

Mesoscopic NS rings : from persistent current to Josephson current

J. Cayssol, T. Kontos, G. Montambaux (Université Paris-Sud, Orsay)

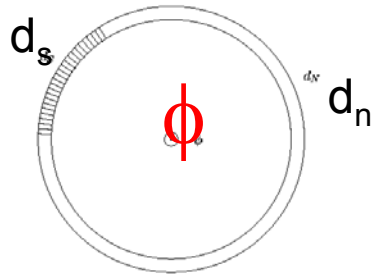

$I(\varphi)$

$\varphi = \phi / \phi_0$

ξ_0 coherence length

$d_s = 0$	\rightarrow	persistent current in normal ring
$d_s \gg \xi_0$	\rightarrow	Josephson current through SNS junction : $\Delta\chi = 4\pi\phi/\phi_0$

$\Phi_0 = h/e$

$h/2e$

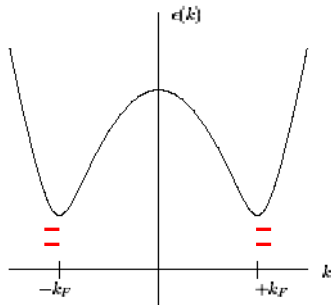

Flux dependent spectrum ?
Current ?
Any d_s and d_n

$$I = -dE/d\phi$$

The current is an equilibrium quantity, but it can be calculated from the excitation spectrum (BdG equations) (Beenakker-Van Houten 91)

$$I = \sum d\varepsilon_n/d\phi$$

Büttiker, Klapwijk (85) : $d_n \gg \xi_0$, many Andreev levels

Spectrum of a 1D NS ring

1D normal ring :

Interlevel spacing $\delta = h v_F / L$

Persistent current $\delta / \phi_0 = e v_F / L$

$$L = d_n + d_s$$

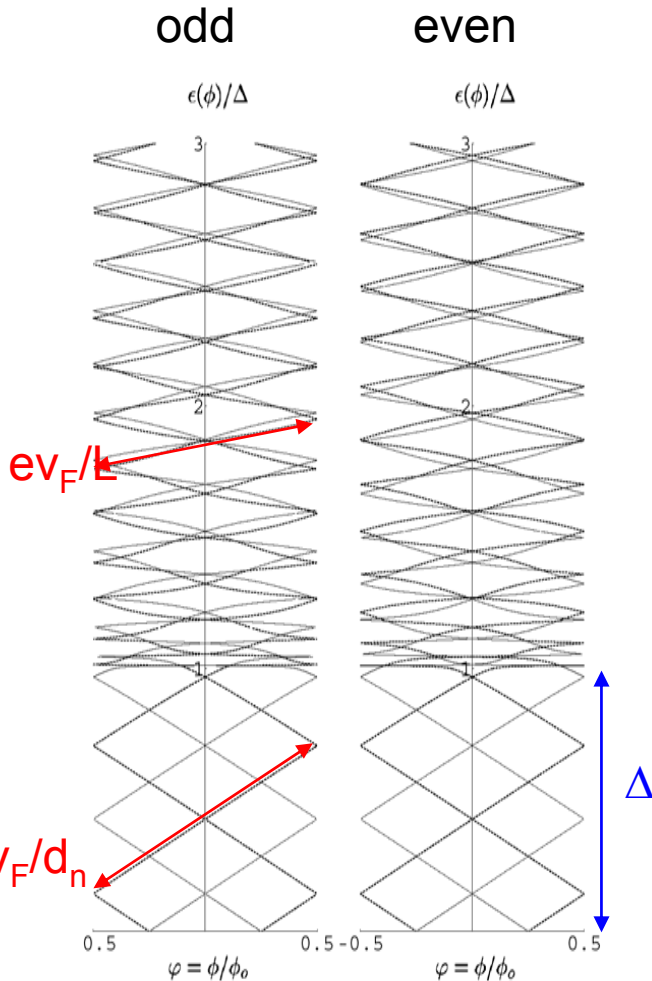
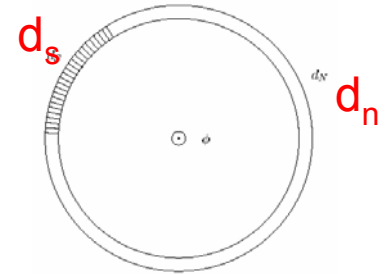

$$d_n = 10 \xi_0, \quad d_s = 20 \xi_0$$

Number of Andreev levels

$$\Delta / (e v_F / d_n) = d_n / \xi_0$$

B.K. : d_n large (many Andreev levels), vary d_s
Assume levels above the gap do not contribute to the current

d_s large : problem equivalent to SNS junction
(**Bardeen, Johnson**) levels above the gap form a continuum

Goals: Treat any d_s and d_n , and cross-overs,
Levels above the gap,
 $d_n \rightarrow 0$, short junction \rightarrow one single Andreev level
Non linear spectrum

d_s finite : levels above the gap are discrete

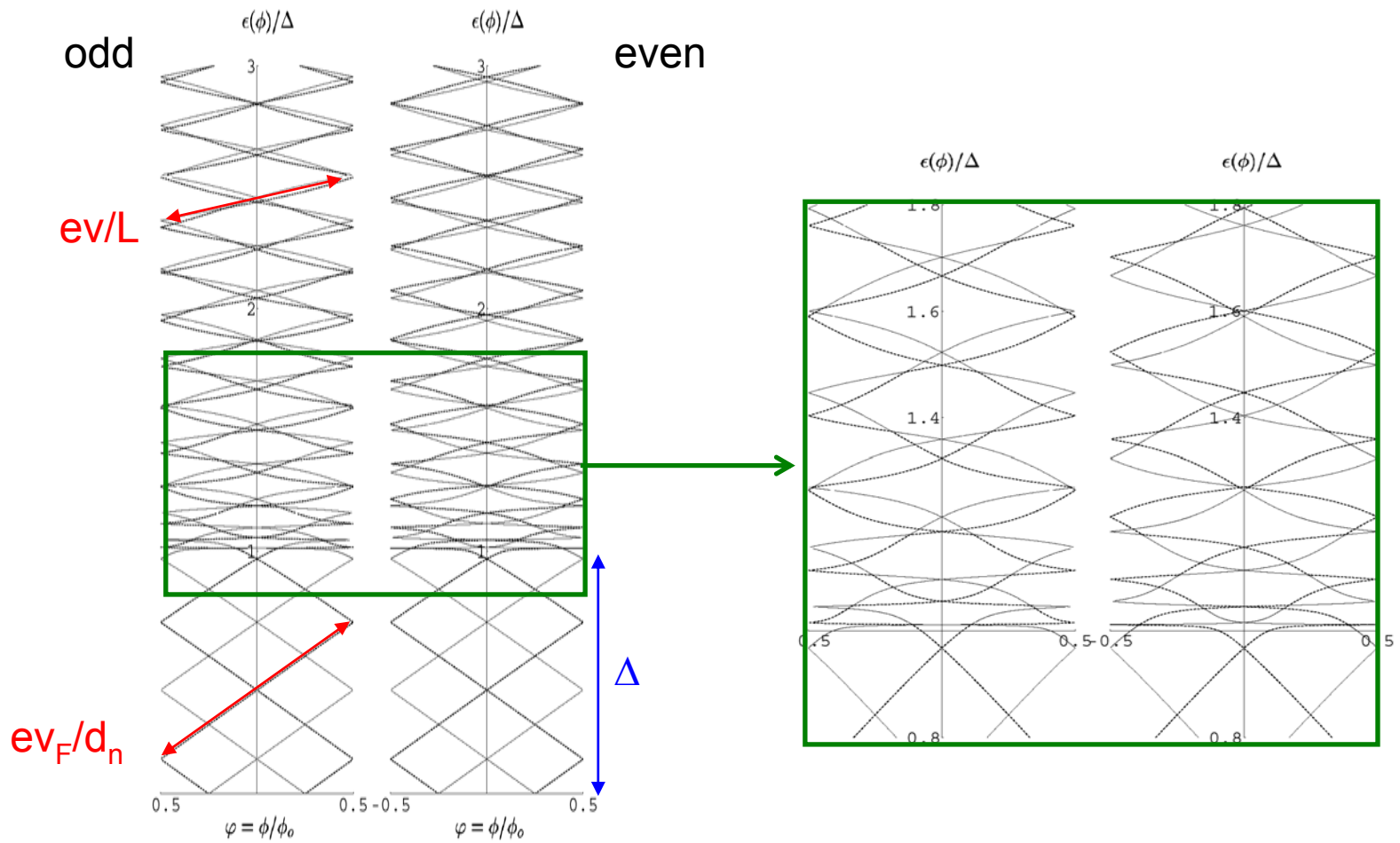

d_n large : linear flux dependence of the Andreev states

Questions

- How to calculate the current ? $I = -dE/d\phi$
- Linearized spectrum \rightarrow No current !
- How to get properly a current from a linearized spectrum ?
- Current of the last level ? How many levels contribute ?
- How to estimate the current of the states near and above the gap?

d_n large : from d_s=0 to d_s large (BK)

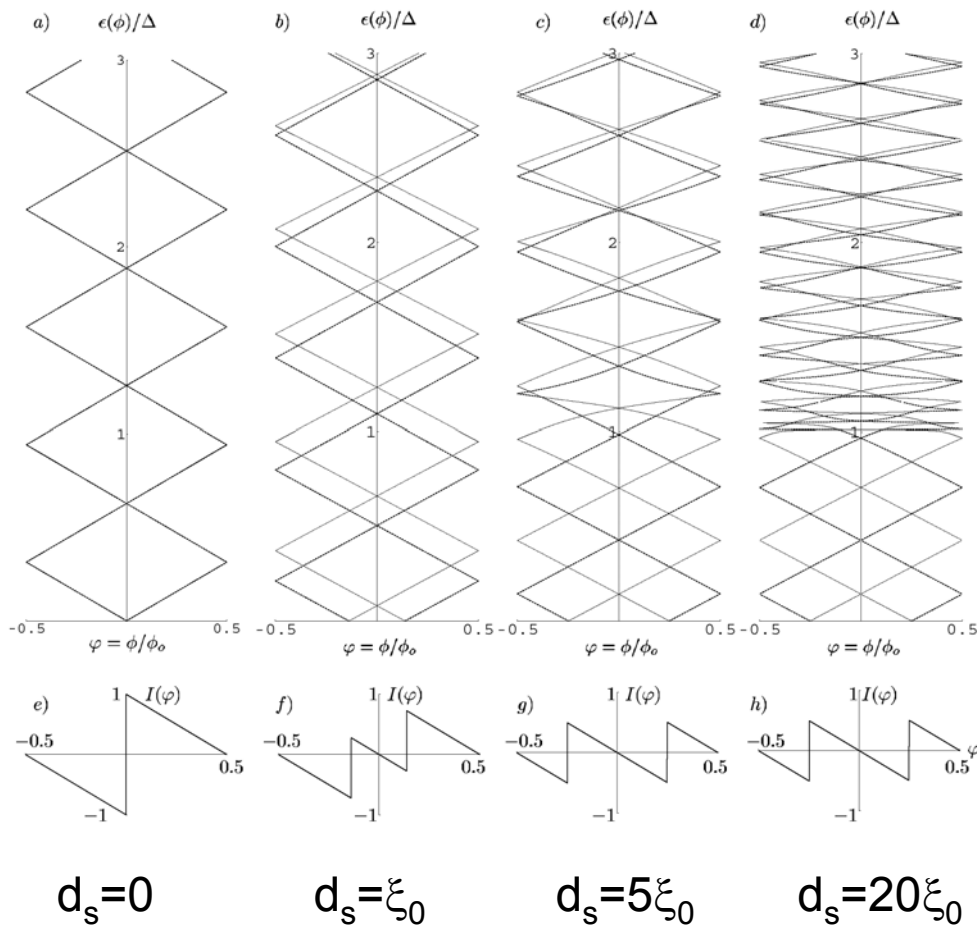

$$d_n = 10 \xi_0$$

$$ev_F / (d_n + d_s)$$

$d_s = 0 \rightarrow$ Phase shift $0, \pi$

$d_s \gg \xi_0 \rightarrow$ Phase shift $\pi/2$

$$d_s \sim \xi_0 \quad \Delta\chi = \text{ArcCos} \frac{(-1)^N}{\text{Cosh } d_s / \xi_0}$$

Parity effect is lost, for Andreev states

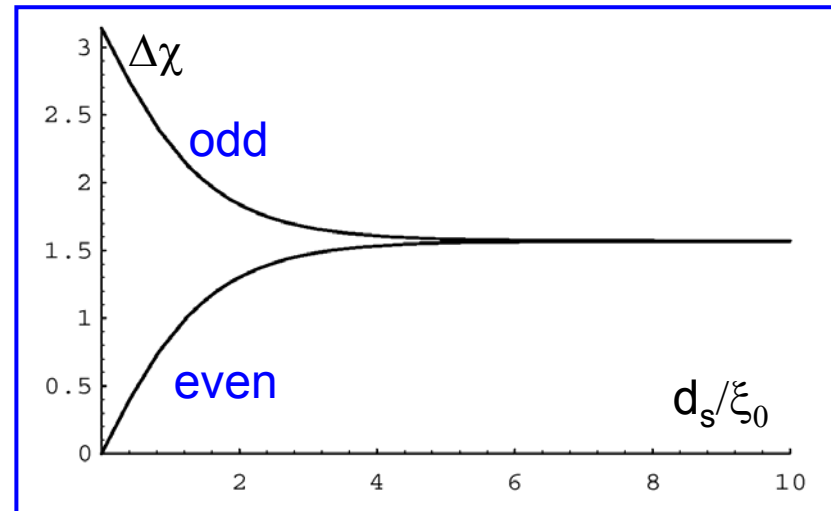

$\Delta\chi(E)$ Non linear levels near the gap

How to calculate the current ?

Persistent current

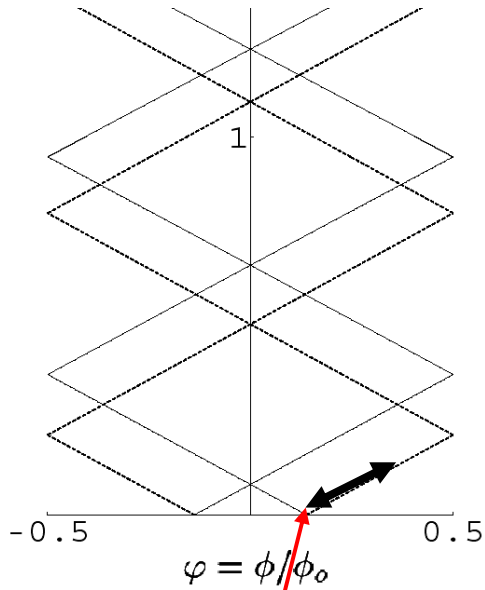

$$y_0 = \frac{1}{2\pi} \Delta\chi$$

Harmonics expansion

$$I(\varphi) = \sum_1^{\infty} I_p \sin 2\pi p\varphi$$

$$\epsilon_n(\varphi) \longrightarrow \text{unfolded } \epsilon(y) \quad , \quad \varphi \in \left[-\frac{1}{2}, \frac{1}{2}\right] \longrightarrow y \in [y_0, \infty]$$

$$I_p = \frac{2}{\pi p} \frac{1}{\phi_0} \left[\epsilon'(y_0) \cos p\Delta\chi - \int_{y_0}^{\infty} dy \epsilon''(y) \cos 2\pi p y \right]$$

piecewise linear $I(\varphi)$

Non-linear correction

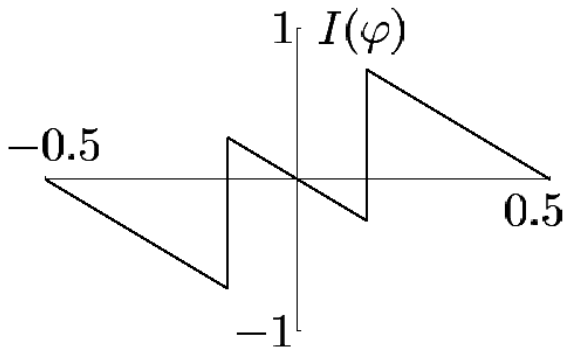

- Each harmonics is an integral over the complete spectrum. It is the sum of :
 - a boundary term evaluated at zero energy + a curvature term integrated over all the spectrum
 - This curvature term can be evaluated and bounded

Example : persistent current of a normal 1D ring

$$I_p = \frac{4}{\pi p} \frac{1}{\phi_o} \left[\epsilon'(y_o) \cos p\Delta\chi - \int_{-\infty}^{y_o} dy \epsilon''(y) \cos 2\pi p y \right]$$

$$\epsilon_n(\varphi) = \frac{\hbar^2}{2mL^2} (n + \varphi)^2 \longrightarrow \epsilon(y) = \frac{\hbar^2}{2mL^2} y^2$$

$$\epsilon'(y_o) = \frac{\hbar v_F}{L} \quad y_o = \frac{k_F L}{2\pi} \quad \epsilon''(y) = \frac{\hbar^2}{mL^2} = \text{Cte}$$

$$I(\varphi) = \frac{4}{\pi} \frac{e v_F}{L} \sum_1^{\infty} \left(\frac{\cos p k_F L}{p} - \frac{\sin p k_F L}{p^2 k_F L} \right) \sin 2\pi p \varphi$$

Cheung, Gefen, Riedel (89)

piecewise linear $I(\varphi)$

Non-linear $1/k_F L$ correction

Curvature term

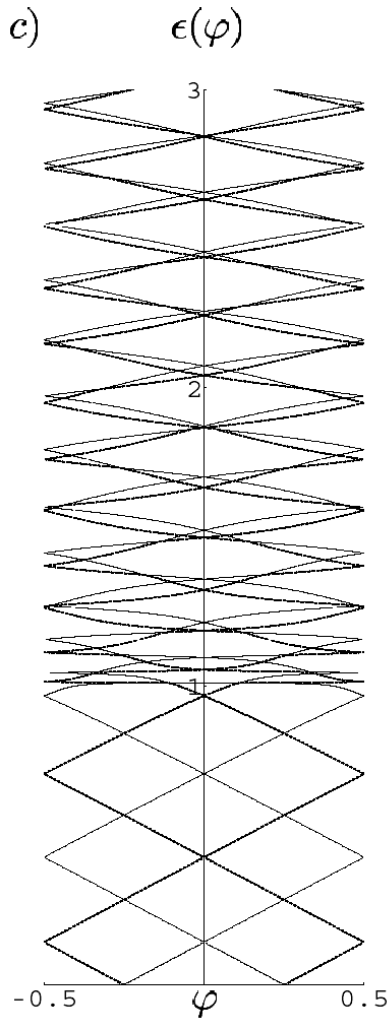

$$d_n = 10 \xi_0$$

d_n large

Andreev levels are linear

States above the gap are non-linear
they do not form a continuum

However non linearities compensate
and the contribution of high energy levels vanishes

d_n small

Andreev levels are non-linear

States near the gap are non-linear

Non-linear flux dependent current

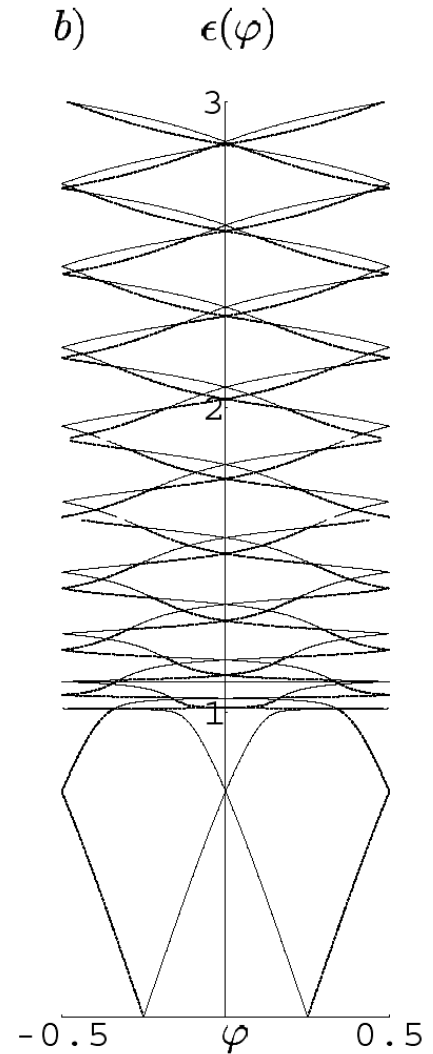

$$d_n = \xi_0$$

Non-linearities

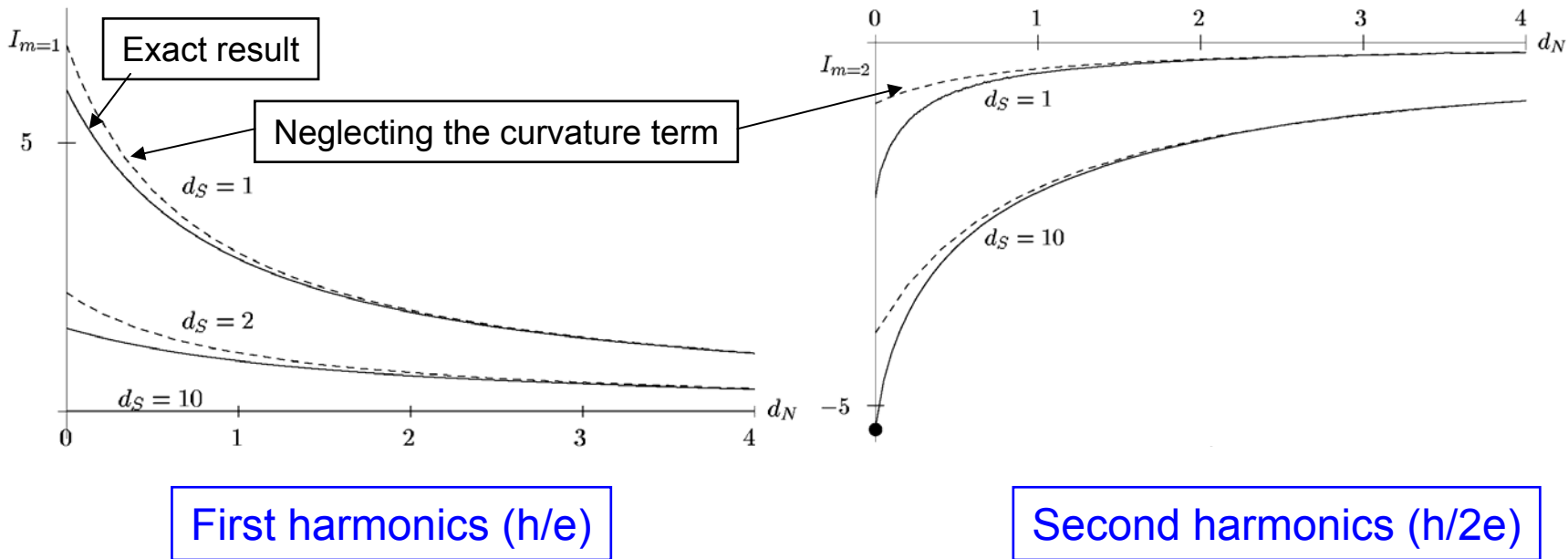

Non-linearities disappear for $d_n > 2 \xi_0$

First harmonic disappear for d_s large
Second harmonics increases with d_s

d_s large : from d_n large to $d_n = 0$

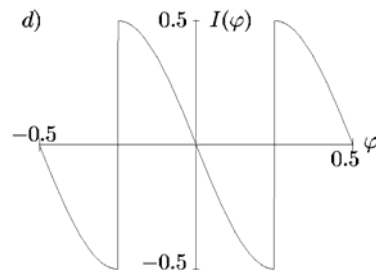
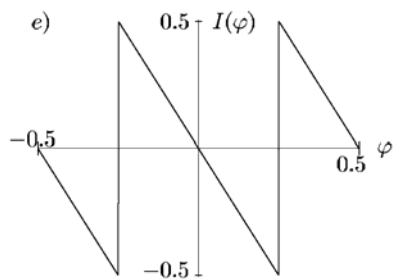
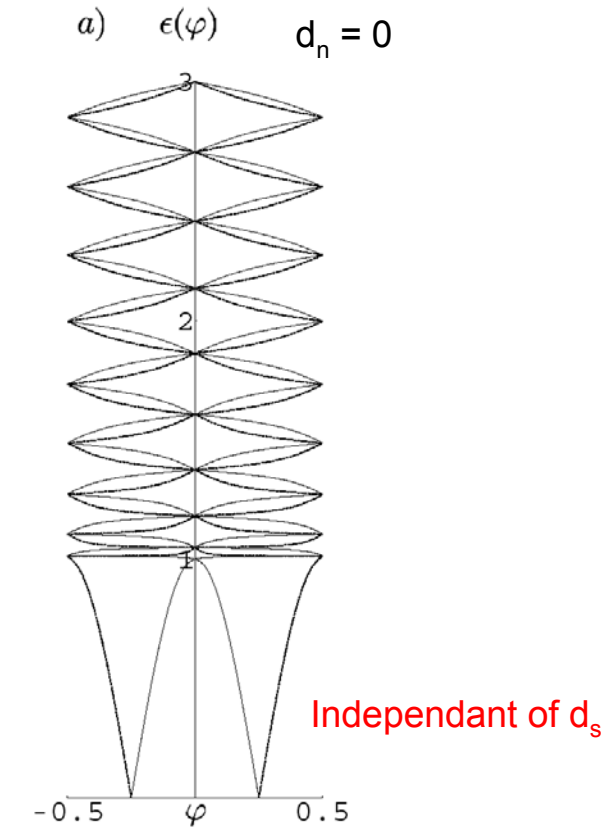
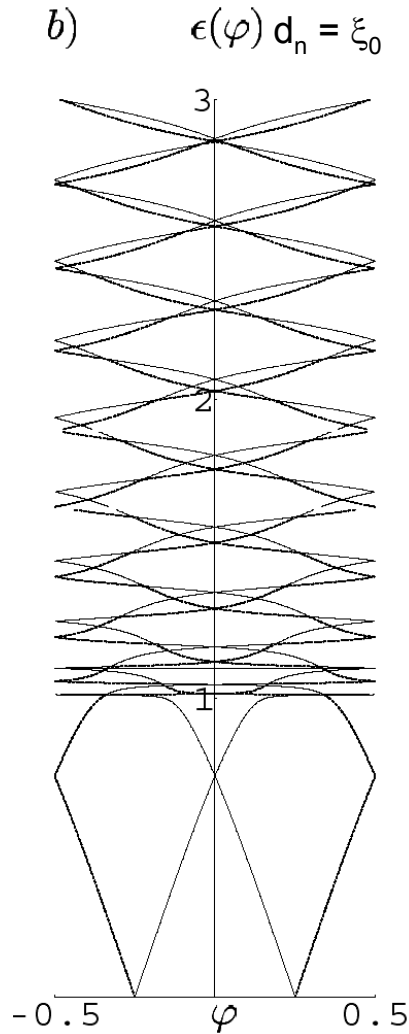
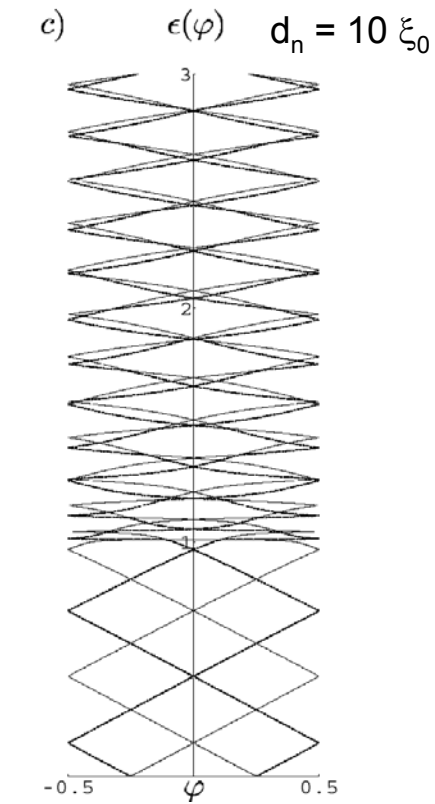

Which levels carry the current ?

Which levels carry the current ?

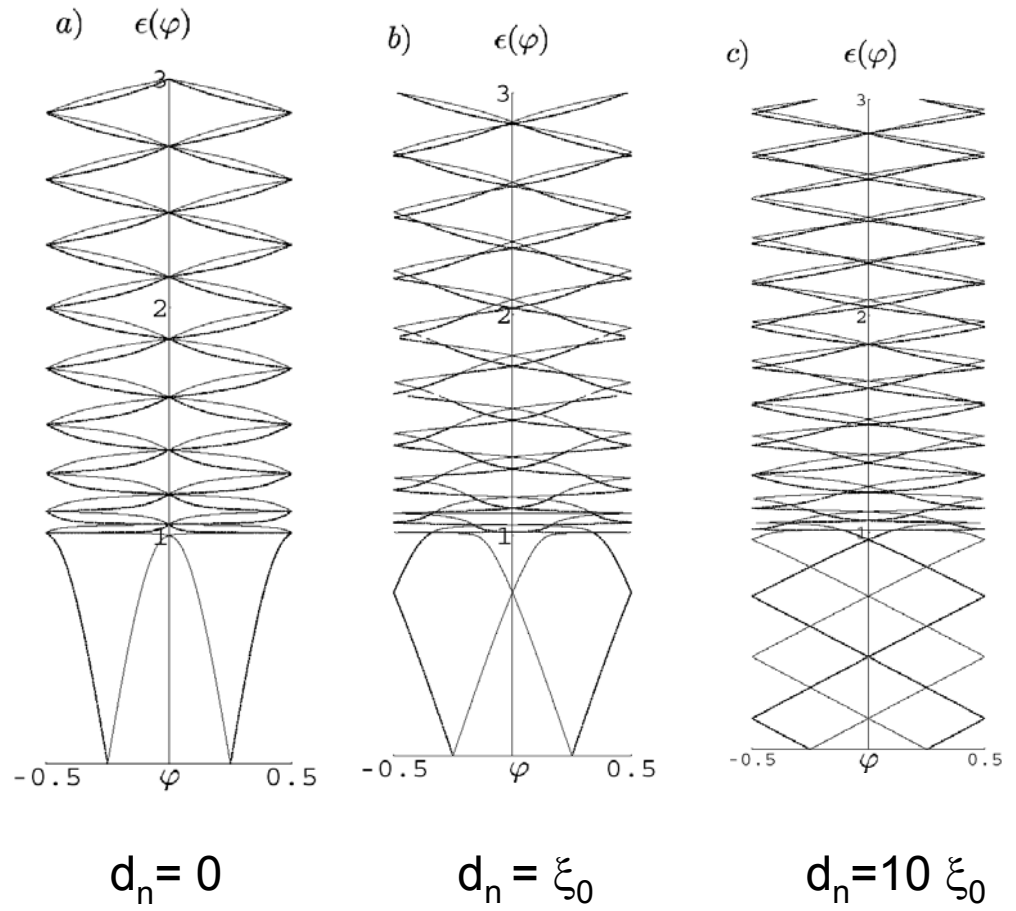
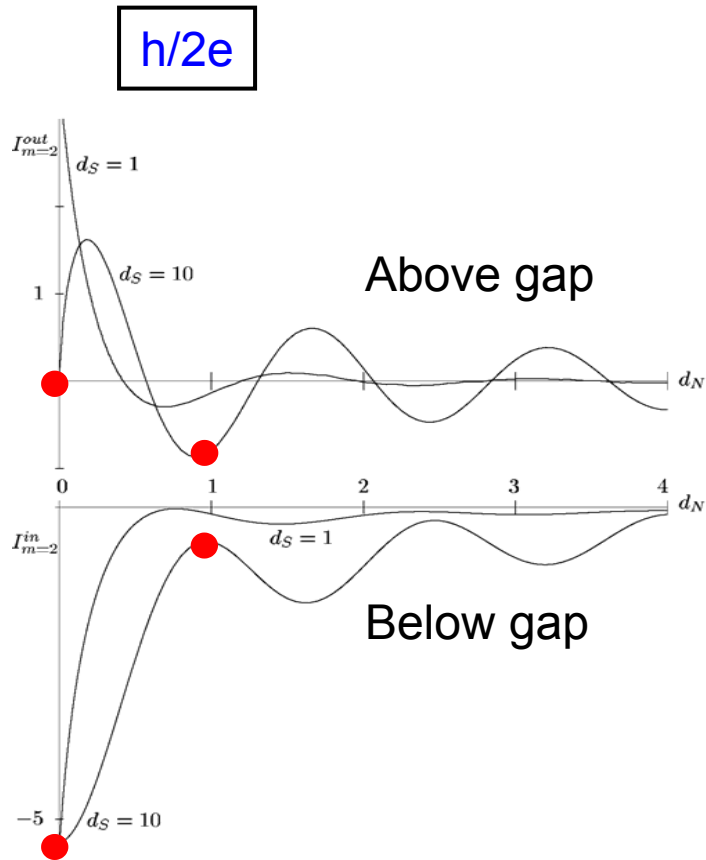

The current is carried by levels **above and below** the gap (even if d_s is large)
 Oscillations as function of d_n with period $\pi \xi_0 / 2$

Ensemble average

Rings with even N
paramagnetic when $d_s=0$
diamagnetic when d_s finite

Rings with odd N
always diamagnetic

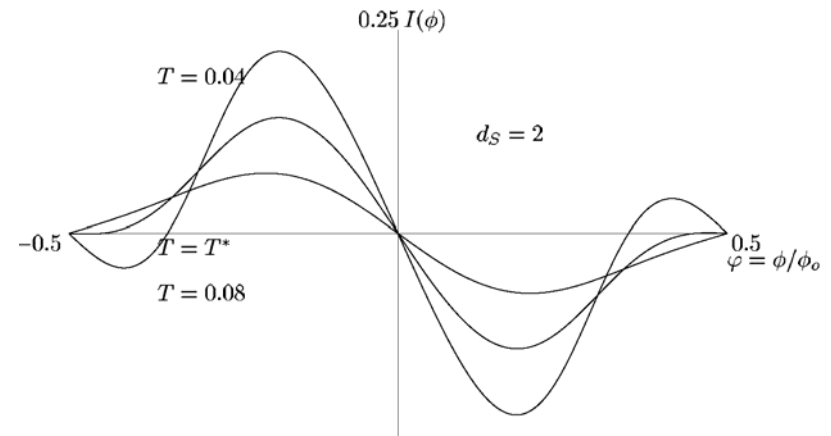
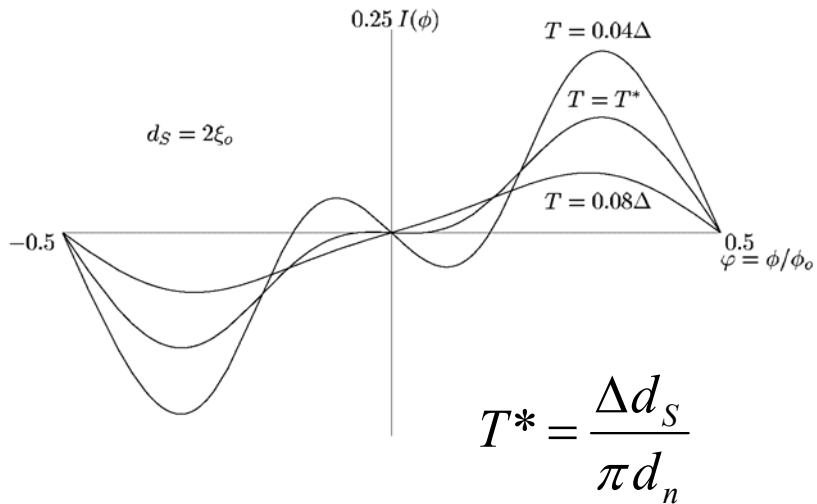

An ensemble of normal rings has a **paramagnetic** magnetization
When $d_s \sim 0,5 \xi_0$, the magnetization becomes **diamagnetic**

Multichannel NS rings

d_n large
 d_s small

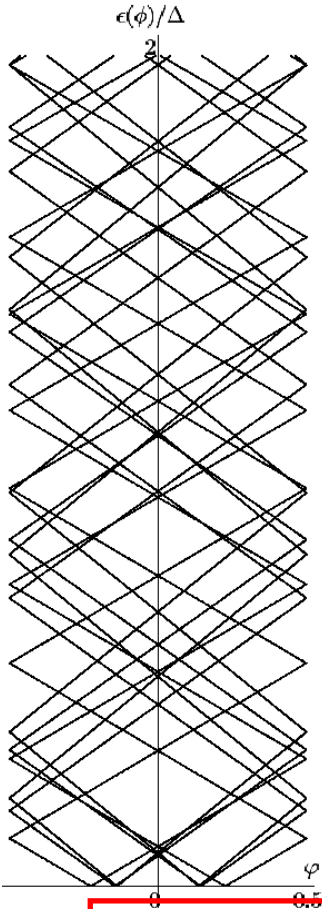

d_n large
 d_s large

$$M e v_F / d_n$$

d_n small
 d_s large

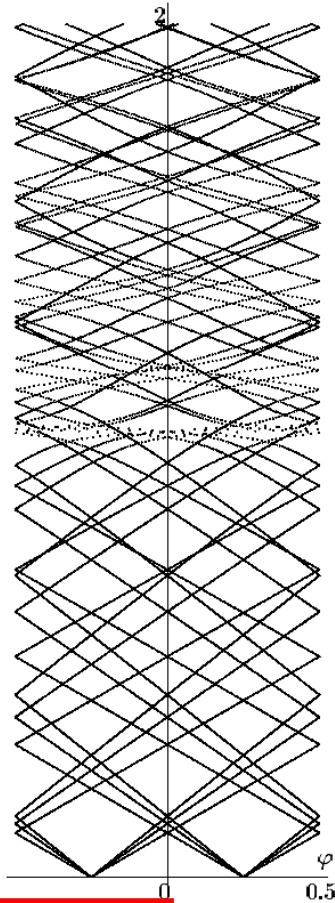

$d_n = 0$
 d_s large

$$M e v_F / \xi_0$$

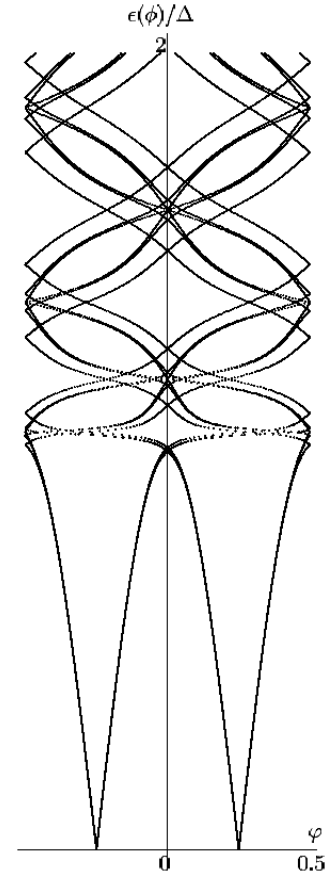
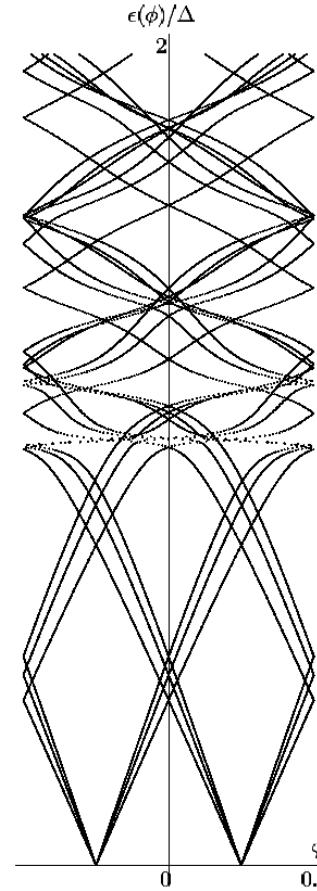

$$\Delta\chi = \text{ArcCos} \frac{\text{Cos} k_{F_x} L}{\text{Cosh} d_s / \xi_0}$$

$d_s < \xi_0$

→ «random» $\Delta\chi$, current averages to 0

$$\Delta\chi = k_{F_x} L \quad (d_s = 0)$$

$d_s > \xi_0$

→ locked $\Delta\chi$, current of M channels

Current of a multichannel ring (d_n large)

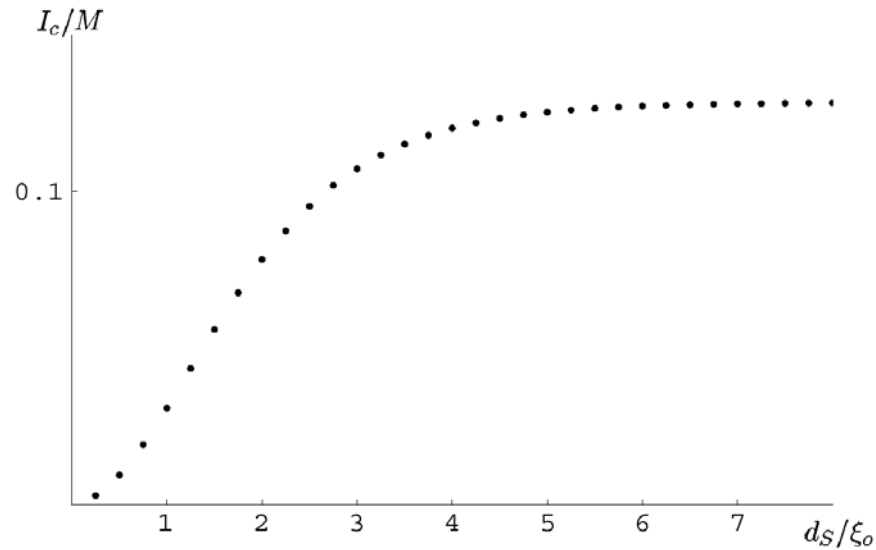

Persistent current ~ 0 \longrightarrow Josephson current $\sim M e v_F/d_n$

Conclusions

- NS 1D and multichannel rings, without disorder
- Full spectrum
- States above the gap do not form a continuum and carry a current
- Persistent current has contributions from linear and non-linear regions of the spectrum
- Cross-over from normal current to Josephson current, vs. d_s and d_n
- Non interacting average current $0 \rightarrow M I_0$, $I_0 = e v_F / d_n$ if $d_n \gg \xi_0$
- Disorder and interactions ? $I_0 = e v_F / \xi_0$ if $d_n \ll \xi_0$

Parameters

d_s d_n	$d_n = \xi_0$ Short junction	$d_n \sim \xi_0$	any d_n	$d_n \gg \xi_0$ long junction
$d_s = 0$				Normal ring Riedel et al.
$d_s \sim \xi_0$				
any d_s	Levels above the gap contribute	Levels above the gap contribute		Buttiker-Klapwijk
$d_s \gg \xi_0$	Beenakker-Van Houten	Levels above the gap contribute		Bardeen-Johnson

unfolding

$$\epsilon_n(\varphi) \longrightarrow \text{unfolded } \epsilon(y) \quad , \quad \varphi \in \left[-\frac{1}{2}, \frac{1}{2}\right] \longrightarrow y \in [y_0, \infty]$$

